

TAPTITE 2000[®]

Thread Rolling Fasteners

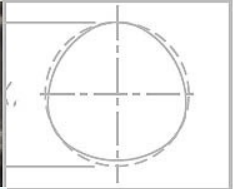
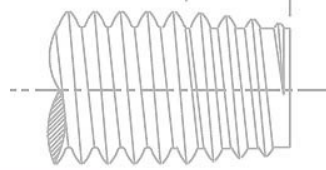
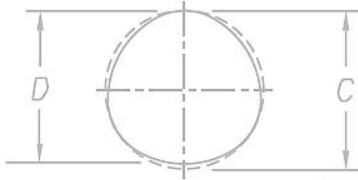

Leaders in Lowering the Cost of Assembly

TAPTITE 2000[®] Fasteners



TAPTITE 2000[®] thread forming technology joins two unique concepts and advances fastener performance to new levels. TAPTITE 2000[®] fasteners afford end-users with enhanced opportunities to reduce the overall **Cost of Assembly**.

TAPTITE 2000[®] fasteners are designed to provide the benefits of prior TAPTITE[®] fastener products with an innovative new thread design - the **Radius Profile[™] Thread**. The proven TRILOBULAR[™] principle is maintained while incorporating the Radius Profile[™] thread. The result is a new generation of TAPTITE 2000[®] fasteners, which provides excellent mechanical, assembly, and ergonomic characteristics surpassed by no other technology.

Radius Profile[™] Thread

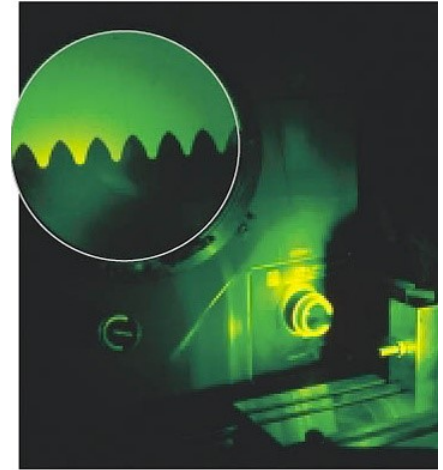

Lower Starting End Load
TAPTITE 2000[®] fasteners require low axial end load to initiate thread forming.

Higher Fail to Drive Ratio
The higher, more uniform, fail to drive ratio of TAPTITE 2000[®] bolts provides a built-in safety factor against over-torquing.

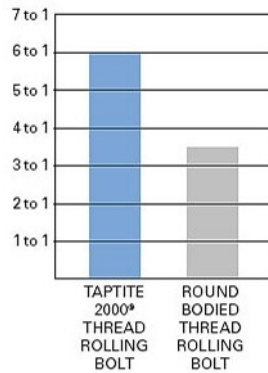
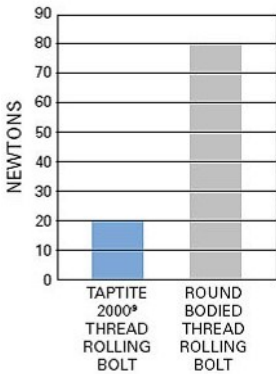

NOTE: End load and fail to drive ratio graphs shown are based on average results recorded when testing an M8 x 1.25 in unthreaded steel weld nuts having a 7.45mm diameter hole.

Attribute	Function
Increased out of round of point threads	Low thread forming torque
	Resists vibrational loosening
TRILOBULAR [®] body	Provides prevailing torque
	Allows deep thread engagements
Reduced out of round on thread body	Provides high axial pull-out loads similar to that achieved using machine screws & bolts

TAPTITE 2000[®] HEAT TREATMENT

TAPTITE 2000[®] bolts perform well in large diameter sizes in deep thread engagements. In the past, the limitations of case-hardened products restricted the exploitation of in-place cost savings for larger diameter TRILOBULAR[®] fasteners. However, TAPTITE 2000[®] screws and bolts are available with 3 different types of heat treatment: CORFLEX[®]-I', CORFLEX[®]-N', and case hardened, making the fasteners adaptable to a wider variety of applications.

CORFLEX[®]-I' Heat Treatment - CORFLEX[®]-I' TAPTITE 2000[®] bolts are neutral hardened to grade strength, metric 8.8, 9.8, 10.9 or any intermediate value. The thread forming zone is selectively induction hardened in order to form threads in untapped nuts. CORFLEX[®]-I' heat treatment allows TAPTITE 2000[®] thread rolling bolts to provide in-place cost savings in large structural applications with strength, ductility and toughness equal to grade strength machine screws or bolts. CORFLEX[®]-I' heat treatment to Grade 10.9 level is standard for TAPTITE 2000[®] bolts in sizes M6 (1/4") and larger.

CORFLEX[®]-N' Heat Treatment - CORFLEX[®]-N' TAPTITE 2000[®] fasteners are neutral hardened to grade 10.9 strength level. CORFLEX[®]-N' products are designed to be used in "soft white" metals such as aluminum or zinc alloys. CORFLEX[®]-N' heat treatment can be specified for any size TAPTITE 2000[®] screws or bolts that are intended to be used in aluminum or zinc alloys.

Case Hardening - Case hardening is the standard heat treatment for all TAPTITE 2000[®] screws in sizes M5 (#12) and smaller.

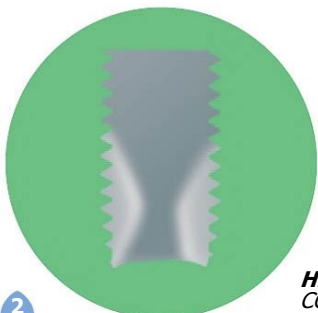

HEAT TAILORED FOR EXTRA TOUGHNESS - Pin-point precision of high hardness zone in axial section of a CORFLEX[®]-I' fastener is shown by the crescent shaped areas in this chemically etched mount.



TAPTITE 2000[®] Fasteners

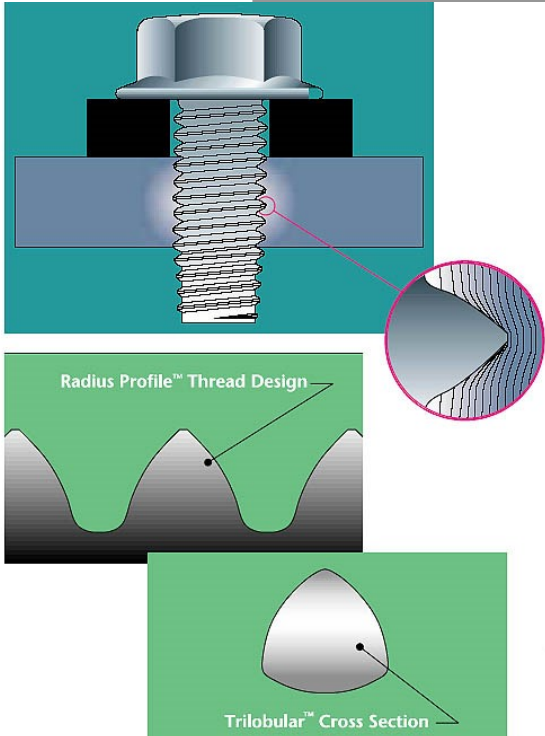

For MR5/IR12 and Smaller

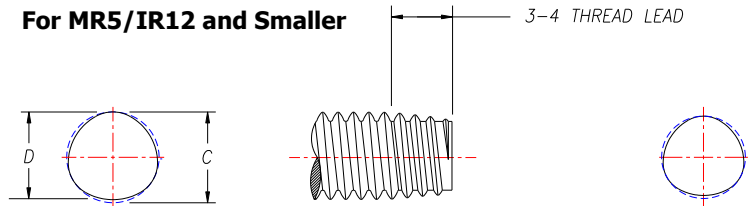

For MR6/IR1/4" and Larger

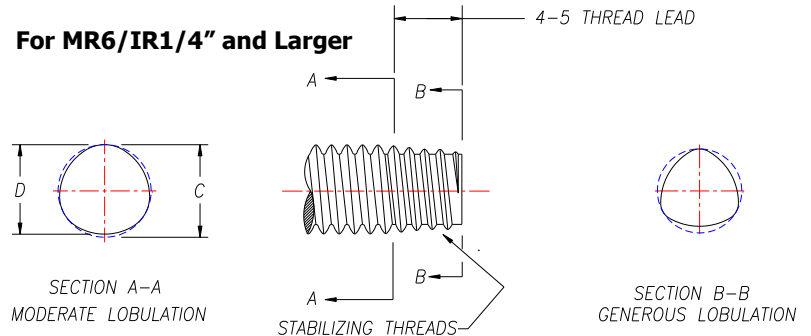

Advantages of the TAPTITE 2000[®] Fastener

- "Ergonomically" Friendly
- "Assembly" Friendly
- Superior Vibration Resistance
- Excellent Axial Alignment
- Low End Load
- High Strip-to-Drive Ratio
- High Prevailing Torque
- Excellent Torque Tension Relationship

SCREW SIZE	SCREW BODY DIMENSIONS			
	C		D	
	Max	Min	Max	Min
Metric Sizes				
MR0.8 x 0.20	0.800	0.770	0.780	0.745
MR1.0 x 0.25	1.000	0.955	0.975	0.924
MR1.2 x 0.25	1.200	1.155	1.175	1.124
MR1.4 x 0.30	1.405	1.355	1.375	1.317
MR1.6 x 0.35	1.61	1.53	1.58	1.49
MR1.8 x 0.35	1.81	1.73	1.78	1.69
MR2.0 x 0.40	2.01	1.93	1.97	1.88
MR2.2 x 0.45	2.21	2.12	2.17	2.06
MR2.5 x 0.45	2.52	2.43	2.48	2.37
MR3.0 x 0.50	3.02	2.93	2.97	2.87
MR3.5 x 0.60	3.52	3.42	3.46	3.35
MR4.0 x 0.70	4.02	3.92	3.95	3.83
MR4.5 x 0.75	4.52	4.41	4.45	4.32
MR5.0 x 0.80	5.02	4.91	4.94	4.81
MR6.0 x 1.00	6.03	5.90	5.93	5.78
MR7.0 x 1.00	7.03	6.90	6.93	6.78
MR8.0 x 1.25	8.03	7.87	7.91	7.71
MR9.0 x 1.25	9.03	8.87	8.91	8.71
MR10 x 1.50	10.03	9.85	9.88	9.66
MR12 x 1.75	12.04	11.83	11.87	11.61
MR14 x 2.00	14.04	13.81	13.84	13.56
MR16 x 2.00	16.04	15.81	15.84	15.56
MR18 x 2.50	18.04	17.76	17.79	17.45
MR20 x 2.50	20.04	19.76	19.79	19.45

SCREW SIZE	SCREW BODY DIMENSIONS			
	C		D	
	Max	Min	Max	Min
Inch Sizes				
IR0 - 80	0.0626	0.0586	0.0613	0.0570
IR2 - 56	0.0880	0.0840	0.0862	0.0818
IR3 - 48	0.1010	0.0970	0.0989	0.0944
IR4 - 40	0.1138	0.1098	0.1113	0.1067
IR5 - 40	0.1268	0.1228	0.1243	0.1197
IR6 - 32	0.1413	0.1353	0.1382	0.1314
IR8 - 32	0.1674	0.1614	0.1643	0.1575
IR10 - 24	0.1934	0.1874	0.1892	0.1822
IR10 - 32	0.1936	0.1876	0.1905	0.1837
IR12 - 24	0.2194	0.2134	0.2152	0.2082
IR1/4 - 20	0.2534	0.2474	0.2484	0.2411
IR5/16 - 18	0.3158	0.3098	0.3102	0.3029
IR3/8 - 16	0.3784	0.3724	0.3721	0.3646
IR7/16 - 14	0.4409	0.4349	0.4338	0.4260
IR7/16 - 20	0.4412	0.4352	0.4362	0.4289
IR1/2 - 13	0.5033	0.4973	0.4956	0.4877
IR9/16 - 12	0.5668	0.5588	0.5585	0.5484
IR5/8 - 11	0.6294	0.6214	0.6203	0.6100

Length Tolerance - Metric per ANSI B18.6.7M	
Nominal Screw Length	Tolerance on Length
to 3mm inclusive	±0.2
over 3 to 10mm inclusive	±0.3
over 10 to 16mm inclusive	±0.4
over 16 to 50mm inclusive	±0.5
over 50mm	±1.0

Length Tolerance - Inch per ANSI B.18.6.3		
Nominal Screw Length	Nominal Screw Size	
	#0 - #12	1/4" - 1/2"
	Tolerance on Length (inches)	
to 1/2" inclusive	+0, -.020	+0, -.030
over 1/2" to 1" inclusive	+0, -.030	+0, -.030
over 1" to 2" inclusive	+0, -.060	+0, -.060
over 2"	+0, -.090	+0, -.090

TAPTITE 2000[®] Fasteners

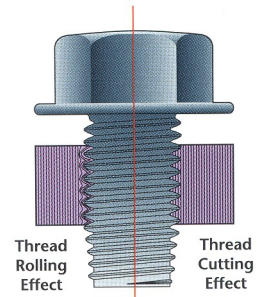

Recommended pilot hole sizes for TAPTITE 2000[®] Screws and Bolts at various percentages of thread engagement

Metric Sizes (mm)

NOMINAL SCREW SIZE	PERCENT THREAD													
	100	95	90	85	80	75	70	65	60	55	50	45	40	35
	PILOT HOLE SIZES													
MR2.5 x 0.45	2.21	2.22	2.24	2.25	2.27	2.28	2.29	2.31	2.32	2.34	2.35	2.37	2.38	2.40
MR3 x 0.5	2.67	2.69	2.71	2.72	2.74	2.76	2.77	2.79	2.80	2.82	2.84	2.85	2.87	2.90
MR3.5 x 0.6	3.11	3.13	3.15	3.17	3.19	3.21	3.23	3.25	3.27	3.29	3.30	3.32	3.34	3.36
MR4 x 0.7	3.54	3.57	3.59	3.61	3.64	3.66	3.68	3.70	3.73	3.75	3.77	3.79	3.80	3.84
MR4.5 x 0.75	4.01	4.04	4.06	4.09	4.11	4.13	4.16	4.18	4.21	4.23	4.26	4.28	4.30	4.33
MR5 x 0.8	4.48	4.51	4.53	4.56	4.58	4.61	4.64	4.66	4.69	4.71	4.74	4.77	4.79	4.82
MR6 x 1.0	5.35	5.38	5.42	5.45	5.48	5.51	5.54	5.58	5.61	5.64	5.67	5.71	5.74	5.77
MR7 x 1.0	6.35	6.38	6.42	6.45	6.48	6.51	6.54	6.58	6.61	6.64	6.67	6.71	6.74	6.77
MR8 x 1.25	7.19	7.23	7.27	7.31	7.35	7.39	7.43	7.47	7.51	7.55	7.59	7.63	7.67	7.72
MR10 x 1.5	9.03	9.07	9.12	9.17	9.22	9.27	9.32	9.37	9.41	9.46	9.51	9.56	9.61	9.66
MR12 x 1.75	10.86	10.92	10.98	11.03	11.09	11.15	11.20	11.26	11.31	11.37	11.43	11.49	11.55	11.60

Inch Sizes (inches)

NOMINAL SCREW SIZE	PERCENT THREAD													
	100	95	90	85	80	75	70	65	60	55	50	45	40	35
	PILOT HOLE SIZES													
IR2 - 56	0.0744	0.0750	0.0756	0.0761	0.0767	0.0773	0.0779	0.0785	0.0790	0.0796	0.0802	0.0808	0.0814	0.0819
IR3 - 48	0.0855	0.0861	0.0868	0.0875	0.0882	0.0888	0.0895	0.0902	0.0909	0.0916	0.0922	0.0929	0.0936	0.0943
IR4 - 40	0.0958	0.0966	0.0974	0.0982	0.0990	0.0998	0.1106	0.1014	0.1023	0.1031	0.1039	0.1047	0.1055	0.1063
IR5 - 40	0.1088	0.1096	0.1104	0.1112	0.1120	0.1128	0.1136	0.1144	0.1153	0.1161	0.1169	0.1177	0.1185	0.1193
IR6 - 32	0.1177	0.1187	0.1197	0.1207	0.1218	0.1228	0.1238	0.1248	0.1258	0.1268	0.1278	0.1289	0.1299	0.1309
IR8 - 32	0.1437	0.1447	0.1457	0.1467	0.1478	0.1488	0.1498	0.1508	0.1518	0.1528	0.1538	0.1549	0.1559	0.1569
IR10 - 24	0.1629	0.1643	0.1656	0.1670	0.1683	0.1697	0.1710	0.1724	0.1738	0.1751	0.1765	0.1778	0.1792	0.1805
IR10 - 32	0.1697	0.1707	0.1717	0.1727	0.1738	0.1748	0.1758	0.1768	0.1778	0.1788	0.1798	0.1809	0.1819	0.1829
IR12 - 24	0.1889	0.1903	0.1916	0.1930	0.1943	0.1957	0.1970	0.1984	0.1998	0.2011	0.2025	0.2038	0.2052	0.2065
IR1/4 - 20	0.2175	0.2191	0.2208	0.2224	0.2240	0.2256	0.2273	0.2289	0.2305	0.2321	0.2338	0.2354	0.2370	0.2386
IR5/16 - 18	0.2764	0.2782	0.2800	0.2818	0.2836	0.2854	0.2872	0.2890	0.2908	0.2926	0.2944	0.2963	0.2981	0.2999
IR3/8 - 16	0.3344	0.3364	0.3384	0.3405	0.3425	0.3445	0.3466	0.3486	0.3506	0.3527	0.3547	0.3567	0.3588	0.3608
IR7/16 - 14	0.3911	0.3934	0.3957	0.3980	0.4004	0.4027	0.4050	0.4073	0.4096	0.4120	0.4143	0.4166	0.4189	0.4213
IR1/2 - 13	0.4500	0.4525	0.4550	0.4575	0.4600	0.4625	0.4650	0.4675	0.4700	0.4725	0.4750	0.4775	0.4800	0.4825

EXAMPLE - The shaded area indicates that an M5 - 0.8 screw size in a 4.58 hole size provides 80% thread engagement. Because the above values are based on a linear relation between hole size and percentage thread engagement, the hole data becomes less accurate for engagements less than 70%.

Pilot Hole Tolerance - in terms of radial thread engagement, min hole = nominal hole + 10%, max hole = nominal - 5%.

Example: M8 - 1.25 in 6.0mm thick steel, nominal hole = 70% thread (7.43mm) per page 5 table.
Min. hole = 80% thread (7.35mm), max hole = 65% thread (7.47mm).

NOTE: All Data Tables in this brochure are for guidance purposes only.



TAPTITE 2000® Fasteners

Recommended pilot hole sizes for TAPTITE 2000® screws and bolts in steel nut members

Metric Sizes (mm)

Application Duty Class	Light 0.3 Diameter of Material			Medium-Light 0.5 Diameter of Material			Medium-Heavy 0.75 Diameter of Material			Full Strength 1.0 Diameter of Material			Extended 1.25 Diameter of Material		
	90%			80%			70%			65%			60%		
Nominal Size	Material Thickness	Pilot Hole	Drill Size	Material Thickness	Pilot Hole	Drill Size	Material Thickness	Pilot Hole	Drill Size	Material Thickness	Pilot Hole	Drill Size	Material Thickness	Pilot Hole	Drill Size
MR2.5 x 0.45	0.5-0.9	2.24	2.25	0.9-1.5	2.27	#43 2.26	1.5-2.1	2.3	2.3	2.1-2.7	2.31	2.3	2.7-3.5	2.32	2.3
MR3 x 0.5	0.5-1.1	2.71	#36 2.71	1.1-1.7	2.74	2.75	1.7-2.7	2.77	7/64 2.78	2.7-3.3	2.79	7/64 2.78	3.3-4.0	2.8	2.8
MR3.5 x 0.6	0.6-1.4	3.15	1/8 3.18	1.4-2.0	3.19	3.2	2.0-2.9	3.23	3.25	2.9-3.8	3.25	3.25	3.8-4.5	3.27	#30 3.27
MR4 x 0.7	0.8-1.4	3.59	3.6	1.4-2.4	3.64	#27 3.66	2.4-3.3	3.68	3.7	3.3-4.4	3.7	3.7	4.4-5.5	3.73	#26 3.73
MR4.5 x 0.75	0.9-1.7	4.06	#21 4.04	1.7-2.7	4.11	4.1	2.7-3.9	4.16	4.2	3.9-4.9	4.18	4.2	4.9-6.4	4.21	4.2
MR5 x 0.8	1.0-2.1	4.53	4.5	2.1-2.9	4.58	#15 4.57	2.9-4.4	4.64	#14 4.62	4.4-5.9	4.66	4.65	5.9-7.1	4.69	4.7
MR6 x 1.0	1.2-2.4	5.42	#3 5.41	2.4-3.6	5.48	5.5	3.6-4.9	5.55	7/32 5.56	4.9-6.9	5.58	5.6	6.9-8.1	5.61	5.6
MR7 x 1.0	1.4-2.4	6.42	6.4	2.4-4.4	6.48	6.5	4.4-6.5	6.55	F 6.53	6.5-7.7	6.58	6.6	7.7-9.5	6.61	6.6
MR8 x 1.25	1.6-3.1	7.27	7.25	3.1-4.9	7.35	L 7.37	4.6-6.9	7.43	7.4	6.9-8.9	7.47	M 7.49	8.9-10.9	7.51	7.5
MR10 x 1.5	1.9-3.9	9.12	23/64 9.1	3.9-5.9	9.22	9.25	5.9-8.3	9.32	9.3	8.3-10.9	9.37	U 9.35	10.9-12.9	9.41	9.4
MR12 x 1.75	2.4-4.9	10.98	11.0	4.9-7.4	11.09	7/16 11.11	7.4-10.5	11.2	7/16 11.11	10.5-14.5	11.26	11.3	14.5-17.0	11.31	11.3

Inch Sizes (inches)

Application Duty Class	Light 0.3 Diameter of Material			Medium-Light 0.5 Diameter of Material			Medium-Heavy 0.75 Diameter of Material			Full Strength 1.0 Diameter of Material			Extended 1.25 Diameter of Material		
	90%			80%			70%			65%			60%		
Nominal Size	Material Thickness	Pilot Hole	Drill Size	Material Thickness	Pilot Hole	Drill Size	Material Thickness	Pilot Hole	Drill Size	Material Thickness	Pilot Hole	Drill Size	Material Thickness	Pilot Hole	Drill Size
IR2 - 56	.017-.034	.0756	1.9mm 0.0748	.034-.052	.0767	1.95mm 0.0763	.052-.073	.0779	5/64 0.0781	.073-.095	.0785	#47 0.0785	.095-.169	.0790	2mm 0.0787
IR3 - 48	.020-.040	.0868	2.2mm 0.0866	.040-.059	.0882	#43 0.089	.059-.084	.0895	#43 0.089	.084-.110	.0902	2.3mm 0.0906	.110-.141	.0909	2.3mm 0.0906
IR4 - 40	.022-.045	.0974	#40 0.098	.045-.067	.0990	#39 0.0995	.067-.095	.1006	#39 0.0995	.095-.126	.1014	#38 0.1015	.126-.157	.1023	2.6mm 0.0906
IR5 - 40	.025-.051	.1104	2.8mm 0.1102	.051-.075	.1120	#33 0.113	.075-.106	.1136	#33 0.113	.106-.141	.1144	2.9mm 0.1142	.141-.175	.1153	2.9mm 0.1142
IR6 - 32	.028-.066	.1197	#31 0.120	.066-.083	.1218	3.1mm 0.122	.083-.117	.1238	1/8 0.125	.117-.152	.1248	1/8 0.125	.152-.193	.1258	3.2mm 0.126
IR8 - 32	.033-.066	.1457	3.7mm 0.1457	.066-.098	.1478	3.75mm 0.1476	.098-.141	.1498	3.8mm 0.1496	.141-.180	.1508	3.8mm 0.1496	.180-.230	.1518	#24 0.152
IR10 - 24	.038-.079	.1656	#19 .166	.079-.114	.1683	#18 0.1695	.114-.162	.1710	11/64 0.1719	.162-.209	.1724	11/64 0.1719	.209-.266	.1738	4.4mm 0.1732
IR10 - 32	.038-.079	.1717	11/64 0.1719	.079-.114	.1738	#17 0.173	.114-.162	.1758	#16 0.177	.162-.209	.1768	#16 0.177	.209-.266	.1779	4.5mm 0.1772
IR12 - 24	.043-.086	.1916	#11 0.191	.086-.130	.1943	#9 0.196	.130-.184	.1970	5mm 0.1969	.184-.238	.1984	#8 0.199	.238-.302	.1998	5.1mm 0.2008
IR1/4 - 20	.050-.100	.2208	#2 0.221	.100-.150	.2240	5.7mm 0.2244	.150-.213	.2273	#1 0.228	.213-.275	.2289	5.8mm 0.2283	.275-.350	.2309	5.8mm 0.2283
IR5/16 - 18	.062-.126	.2800	7.1mm 0.2795	.126-.188	.2836	7.2mm 0.2835	.188-.266	.2872	7.3mm 0.2874	.266-.345	.2890	L 0.29	.345-.438	.2908	7.4mm 0.2913
IR3/8 - 16	.075-.150	.3384	8.6mm 0.3386	.150-.225	.3425	8.7mm 0.3425	.225-.319	.3466	8.8mm 0.3465	.319-.413	.3486	Size 0.348	.413-.525	.3506	8.8mm 0.3504
IR7/16 - 14	.087-.174	.3957	X 0.397	.174-.262	.4004	X 0.397	.262-.371	.4050	Y 0.404	.371-.481	.4073	13/32 0.4063	.481-.612	.4096	13/32 0.4063
IR1/2 - 13	.100-.200	.4550	29/64 0.4531	.200-.300	.4600	29/64 0.4531	.300-.425	.4650	15/32 0.4688	.425-.550	.4675	15/32 0.4688	.550-.700	.4700	15/32 0.4688

APPLICATION DUTY CLASS - A general term used here to group material thickness in terms of screw diameters. For example, the average material thickness listed under "medium-heavy" equals 75% of the screw diameter.

TAPTITE 2000[®] Fasteners

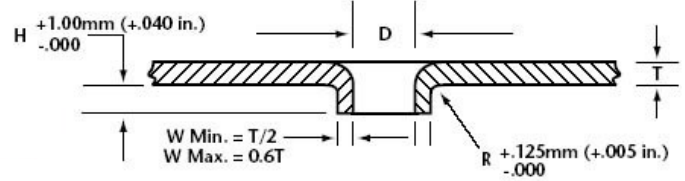

Recommended extruded pilot hole sizes in light-gauge steel for TAPTITE 2000[®] Screws and Bolts

Metric Sizes (mm)

Material Thickness	0.5 - 0.69	0.7 - 0.99	1.0 - 1.49	1.5 - 2.49	2.5 - 3.0
Screw Size	Hole Size Diameter - D				
MR2.5 x 0.45	2.22	2.23	2.24	---	---
MR3 x 0.5	2.70	2.71	2.72	---	---
MR4 x 0.7	3.57	3.59	3.61	3.64	---
MR5 x 0.8	---	4.53	4.56	4.59	---
MR6 x 1.0	---	5.42	5.45	5.48	5.51
MR8 x 1.25	---	---	7.27	7.31	7.35

Extruding holes for fasteners in light-gauge steel nearly doubles the length of thread engagement over the original material thickness.

TAPTITE 2000[®] screws and bolts develop almost twice the failure torque in extruded holes, providing maximum joint integrity.

Example: The chart shows that for a M4 x 0.7 screw in a material thickness of 0.75mm the suggested hole diameter is 3.59mm. The corresponding "H" dimension is the 1.35mm minimum, making the total length of engagement 2.1mm minimum.

Approximate Material Thickness "T"

Metric	0.6 - 1.0		1.0 - 1.2		1.2 - 2.0		2.0 - 2.5		2.5 - 3.0	
Hole Dia.-D	H	R	H	R	H	R	H	R	H	R
2.00 - 2.55	1.00	0.13	1.00	0.13	1.00	0.15	1.10	0.25	---	---
2.56 - 3.20	1.20	0.13	1.20	0.13	1.20	0.15	1.30	0.25	1.35	0.25
3.21 - 3.80	1.35	0.13	1.35	0.13	1.35	0.15	1.50	0.25	1.60	0.25
3.81 - 4.60	---	---	1.50	0.13	1.55	0.15	1.80	0.25	1.90	0.25
4.61 - 5.60	---	---	1.80	0.13	1.80	0.15	2.30	0.25	2.40	0.25
5.61 - 6.60	---	---	---	---	1.90	0.15	2.55	0.25	2.65	0.25
6.61 - 7.60	---	---	---	---	2.10	0.15	2.95	0.25	3.20	0.25

Inch Sizes (inches)

Material Thickness	.020 - .029	.030 - .039	.040 - .059	.060 - .099	.100 - .130
Screw Size	Hole Size Diameter - D				
IR4 - 40	0.097	0.097	0.098	---	---
IR6 - 32	0.119	0.120	0.121	0.122	---
IR8 - 32	0.145	0.146	0.147	0.148	---
IR10 - 24	0.164	0.166	0.168	0.170	0.170
IR10 - 32	0.171	0.172	0.173	0.174	0.174
IR1/4 - 20	---	0.221	0.223	0.225	0.225
IR5/16 - 18	---	---	0.282	0.285	0.285

Approximate Material Thickness "T"

Inch	.020 - .035		.035 - .050		.050 - .075		.075 - .100		.100 - .125	
Hole Dia.-D	H	R	H	R	H	R	H	R	H	R
.081 - .100	0.040	0.005	0.040	0.005	0.040	0.006	0.043	0.010	---	---
.101 - .125	0.047	0.005	0.047	0.005	0.047	0.006	0.052	0.010	0.054	0.010
.126 - .150	0.053	0.005	0.053	0.005	0.053	0.006	0.060	0.010	0.063	0.010
.151 - .181	---	---	0.060	0.005	0.060	0.006	0.070	0.010	0.075	0.010
.181 - .220	---	---	0.070	0.005	0.070	0.006	0.090	0.010	0.095	0.010
.221 - .260	---	---	---	---	0.075	0.006	0.100	0.010	0.105	0.010
.261 - .300	---	---	---	---	0.083	0.006	0.116	0.010	0.125	0.010



TAPTITE 2000[®] "CA" Fasteners

The CA point can be supplied with a sharp point or a slightly truncated blunt point - which is desirable for situations when the sharp point could be a potential hazard to wires, components or assembly line and service personnel.

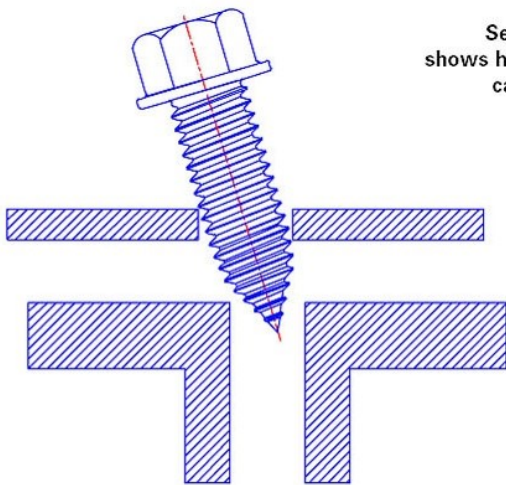
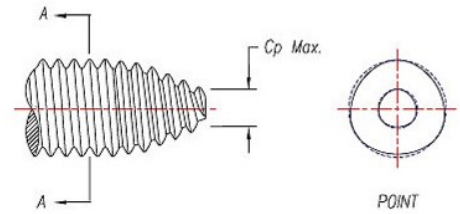
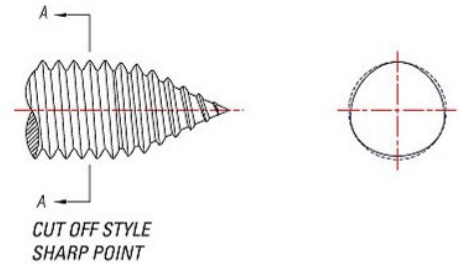
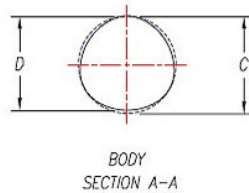
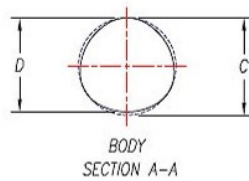

Section view shows hole-finding capability of CA Point.

TAPTITE 2000[®] CA fasteners have a gimlet point for use when clearance holes and pilot holes do not align.

The CA point is also good for rapid hole finding, floating nut members or difficult access applications.

TAPTITE 2000[®] CA fasteners can be produced with any of our heat treatment processes; case hardened - our standard heat treatment for sizes M5 (#12) or smaller, CORFLEX[®]-‘I’ induction hardened for structural or demanding applications or CORFLEX[®]-‘N’, neutral hardened non-ferrous applications.

See page 2 for a more detailed description of the available heat treat options.

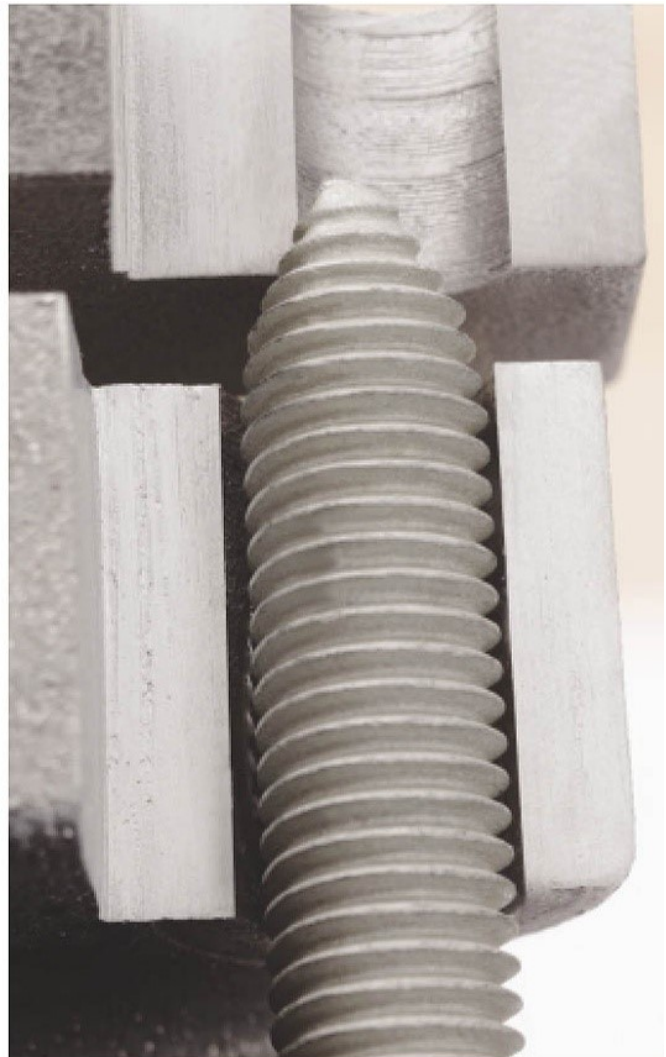

TAPTITE 2000® "SP"™ Fasteners

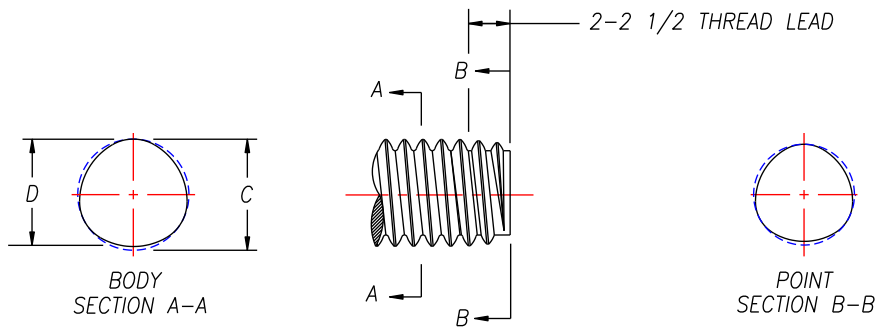

TAPTITE 2000® "SP"™ fasteners have a shorter point than standard TAPTITE 2000® fasteners to maximize the full thread engagement in shallow blind holes, particularly in non-ferrous materials.

TAPTITE 2000® "SP"™ fasteners are primarily used in aluminum and therefore are supplied with CORFLEX®-'N' heat treatment to minimize the potential of stress corrosion. When used in steel material, TAPTITE 2000® "SP"™ fasteners can be ordered with the case hardened or CORFLEX®-'I' heat treatment - see page 2 for details.

The short (2 - 2½) point of the TAPTITE 2000® "SP"™ fastener increases the amount of full thread engagement in blind holes. Increasing the full thread engagement is often critical in shallow depth holes. In many cases the failure mode can be changed from internal nut threads stripping to the fastener breaking, which is usually desired in castings. In deeper holes, the shorter "SP" point may allow a shorter fastener, saving weight and cost.



SCREW SIZE	SCREW BODY DIMENSIONS			
	C		D	
	Max	Min	Max	Min
Metric Sizes				
MR0.8 x 0.20	0.800	0.770	0.780	0.745
MR1.0 x 0.25	1.000	0.955	0.975	0.924
MR1.2 x 0.25	1.200	1.155	1.175	1.124
MR1.4 x 0.30	1.405	1.355	1.375	1.317
MR1.6 x 0.35	1.61	1.53	1.58	1.49
MR1.8 x 0.35	1.81	1.73	1.78	1.69
MR2.0 x 0.40	2.01	1.93	1.97	1.88
MR2.2 x 0.45	2.21	2.12	2.17	2.06
MR2.5 x 0.45	2.52	2.43	2.48	2.37
MR3.0 x 0.50	3.02	2.93	2.97	2.87
MR3.5 x 0.60	3.52	3.42	3.46	3.35
MR4.0 x 0.70	4.02	3.92	3.95	3.83
MR4.5 x 0.75	4.52	4.41	4.45	4.32
MR5.0 x 0.80	5.02	4.91	4.94	4.81
MR6.0 x 1.00	6.03	5.90	5.93	5.78
MR7.0 x 1.00	7.03	6.90	6.93	6.78
MR8.0 x 1.25	8.03	7.87	7.91	7.71
MR9.0 x 1.25	9.03	8.87	8.91	8.71
MR10 x 1.50	10.03	9.85	9.88	9.66
MR12 x 1.75	12.04	11.83	11.87	11.61
MR14 x 2.00	14.04	13.81	13.84	13.56
MR16 x 2.00	16.04	15.81	15.84	15.56
MR18 x 2.50	18.04	17.76	17.79	17.45
MR20 x 2.50	20.04	19.76	19.79	19.45

SCREW SIZE	SCREW BODY DIMENSIONS			
	C		D	
	Max	Min	Max	Min
Inch Sizes				
IR2 - 56	0.0880	0.0840	0.0862	0.0818
IR3 - 48	0.1010	0.0970	0.0989	0.0944
IR4 - 40	0.1138	0.1098	0.1113	0.1067
IR5 - 40	0.1268	0.1228	0.1243	0.1197
IR6 - 32	0.1413	0.1353	0.1382	0.1314
IR8 - 32	0.1674	0.1614	0.1643	0.1575
IR10 - 24	0.1934	0.1874	0.1892	0.1822
IR10 - 32	0.1936	0.1876	0.1905	0.1837
IR12 - 24	0.2194	0.2134	0.2152	0.2082
IR1/4 - 20	0.2534	0.2474	0.2484	0.2411
IR5/16 - 18	0.3158	0.3098	0.3102	0.3029
IR3/8 - 16	0.3784	0.3724	0.3721	0.3646
IR7/16 - 14	0.4409	0.4349	0.4338	0.4260
IR7/16 - 20	0.4412	0.4352	0.4362	0.4289
IR1/2 - 13	0.5033	0.4973	0.4956	0.4877
IR9/16 - 12	0.5668	0.5588	0.5585	0.5484
IR5/8 - 11	0.6294	0.6214	0.6203	0.6100

NOTE: "SP"™ designates Short Point



TAPTITE 2000[®] "SP"[™] Fasteners

Recommended pilot hole sizes for aluminum or zinc alloy die castings for TAPTITE 2000[®] "SP"[™] fasteners

Screw Size	ØF Hole Dia. Drilled	Hole Diameter as Cast				Engagement Length		ØH Boss Dia. Min.
		Top ØA		Bottom ØB		Lf - Full Thread	Ld - With Point	
		Max.	Min.	Max.	Min.			
Metric Sizes (mm)								
M2 x 0.40	1.82	1.90	1.86	1.80	1.76	4.0	5.00	3.32
M2.5 x 0.45	2.29	2.40	2.36	2.27	2.23	5.0	6.13	4.15
M3 x 0.5	2.77	2.90	2.85	2.75	2.70	6.0	7.25	4.98
M3.5 x 0.6	3.23	3.38	3.32	3.20	3.14	7.0	8.50	5.81
M4 x 0.7	3.68	3.85	3.78	3.65	3.58	8.0	9.75	6.64
M5 x 0.8	4.64	4.85	4.77	4.60	4.52	10.0	12.00	8.30
M6 x 1.0	5.54	5.79	5.71	5.49	5.41	12.0	14.50	9.96
M8 x 1.25	7.43	7.75	7.67	7.35	7.27	16.0	19.13	13.28
M10 x 1.5	9.32	9.71	9.63	9.21	9.13	20.0	23.75	16.60
M12 x 1.75	11.20	11.67	11.59	11.07	10.99	24.0	28.38	19.92
Inch Sizes (in)								
2 - 56	0.078	0.082	0.080	0.077	0.075	0.172	0.217	0.143
4 - 40	0.101	0.105	0.103	0.099	0.097	0.224	0.287	0.186
6 - 32	0.124	0.130	0.127	0.122	0.119	0.276	0.354	0.229
8 - 32	0.150	0.157	0.154	0.148	0.145	0.328	0.406	0.272
10 - 24	0.171	0.179	0.176	0.169	0.165	0.380	0.485	0.315
10 - 32	0.176	0.184	0.181	0.174	0.171	0.380	0.458	0.315
12 - 24	0.197	0.206	0.203	0.195	0.191	0.432	0.537	0.359
1/4 - 20	0.227	0.237	0.234	0.224	0.221	0.500	0.625	0.415
5/16 - 18	0.287	0.299	0.296	0.283	0.280	0.624	0.764	0.518
3/8 - 16	0.347	0.361	0.358	0.342	0.339	0.750	0.908	0.623
1/2 - 13	0.465	0.484	0.481	0.459	0.456	1.000	1.193	0.830

The above full thread engagement length set to 2x diameter to obtain good performance. Depending on casting material and fastener heat treat, deeper length of engagement may be advantageous, especially if obtaining maximum screw strength is desirable - shallower depths of engagements may be used if reduced performance is acceptable.

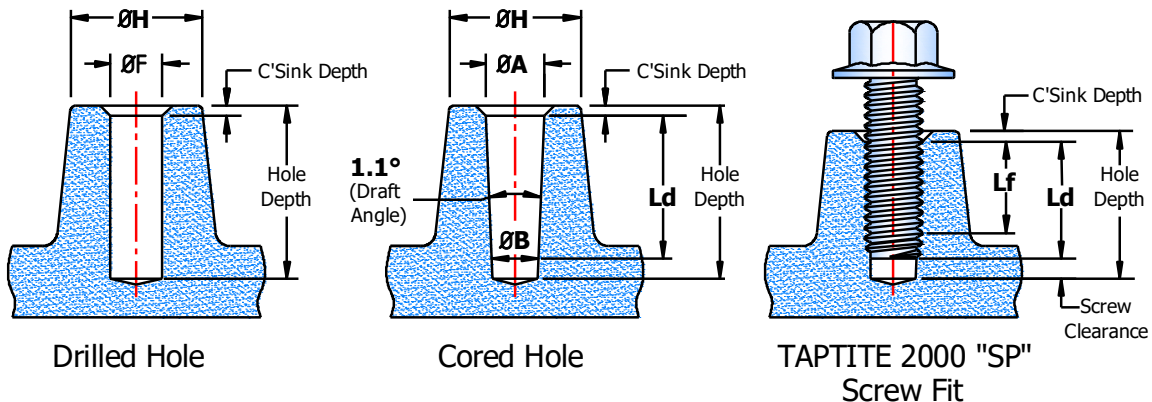

* For sizes not in table, contact Engineering



TORQUE PERFORMANCE

The thread body lobulation and Radius Profile™ thread design of TAPTITE 2000[®] fasteners provides torque-tension relationships similar to those that are achieved using machine screws.

Metric Sizes (Nm)

Screw Size	Plate Thickness	Hole Size	Nearest Drill Size	Thread Forming Torque	Prevailing First Removal	Recommended Assembly Torque	Failure Torque
MR3 x 0.5	1.0	2.71	#36	0.25 - 0.40	0.15 - 0.25	1.00	1.60 - 2.2*
	2.0	2.77	7/64	0.30 - 0.50	0.15 - 0.25	1.00	1.70 - 2.8*
	3.0	2.77	7/64	0.45 - 0.70	0.20 - 0.35	1.60	2.70 - 3.9*†
MR4 x 0.7	2.0	3.64	#27	0.55 - 0.75	0.25 - 0.35	1.80	3.10 - 4.2*
	3.0	3.68	3.7	0.80 - 1.15	0.45 - 0.60	3.30	6.00 - 8.2*
	4.0	3.70	3.7	1.10 - 1.45	0.50 - 0.70	4.30	7.70 - 11*†
MR5 x 0.8	2.5	4.58	#15	1.15 - 1.80	0.50 - 0.70	2.80	5.80 - 8.8*
	3.5	4.64	#14	1.35 - 2.45	0.75 - 1.30	6.00	11.0 - 13.5*
	5.0	4.66	4.65mm	1.80 - 2.70	0.75 - 1.30	7.00	12.0 - 15.5†
MR6 x 1.0	3.0	5.48	5.5mm	1.80 - 2.50	0.50 - 1.00	5.00	9.90 - 14.5*
	4.5	5.55	7/32	2.90 - 4.00	0.75 - 1.30	10.0	17.5 - 23.0*
	6.0	5.58	5.6mm	3.15 - 4.30	0.85 - 1.40	10.0	20.0 - 27.5*†
MR8 x 1.25	4.0	7.35	L	4.30 - 6.30	1.30 - 2.40	20.0	36.0 - 46.0*
	6.0	7.43	7.4	4.95 - 8.50	1.85 - 3.00	28.0	47.0 - 58.0*
	8.0	7.47	M	6.30 - 10.8	3.5 - 5.0	30.0	60.5 - 71.5†
MR10 x 1.5	5.0	9.22	9.2mm	10.0 - 13.5	4.5 - 6.0	30.0	58.0 - 70.0*
	8.0	9.32	9.3mm	12.5 - 17.0	5.0 - 7.5	45.0	88.0 - 100*
	10.0	9.37	U	13.5 - 20.0	6.0 - 10.0	55.0	100 - 115†
MR12 x 1.75	6.0	11.09	7/16	20.5 - 26.0	6.0 - 11.0	60.0	120 - 145*
	9.0	11.20	7/16	22.5 - 28.0	7.5 - 13.0	65.0	125 - 150*
	12.0	11.26	11.3	27.0 - 34.0	11.0 - 17.0	100	190 - 220†

Notes:

- All torque values - Nm
- Performance was developed using Hex Flange head screws, zinc plated plus wax, driven at low speed under laboratory conditions into cold rolled steel test plates with plain flat steel washers under screw head to absorb tightening.
- Values shown represent the above conditions only and should not be used in lieu of proper application testing. Having a thicker or thinner nut member, harder or softer material, different hole, can all contribute to variations in the torque performance listed.
- Prevailing first removal torque, the torque necessary to remove the screw after the head has been unseated, is an indication of TAPTITE 2000[®] screws' inherent resistance to loosening under vibration, even without the screw head being seated.

* Indicates probability nut threads will strip
 † indicates probability screw will break.

TAPTITE 2000[®] Fastener
Torque Performance in Through Hole
 M8 - 1.00 TAPTITE 2000[®] Fastener - 8.0mm Steel, 7.45mm Hole

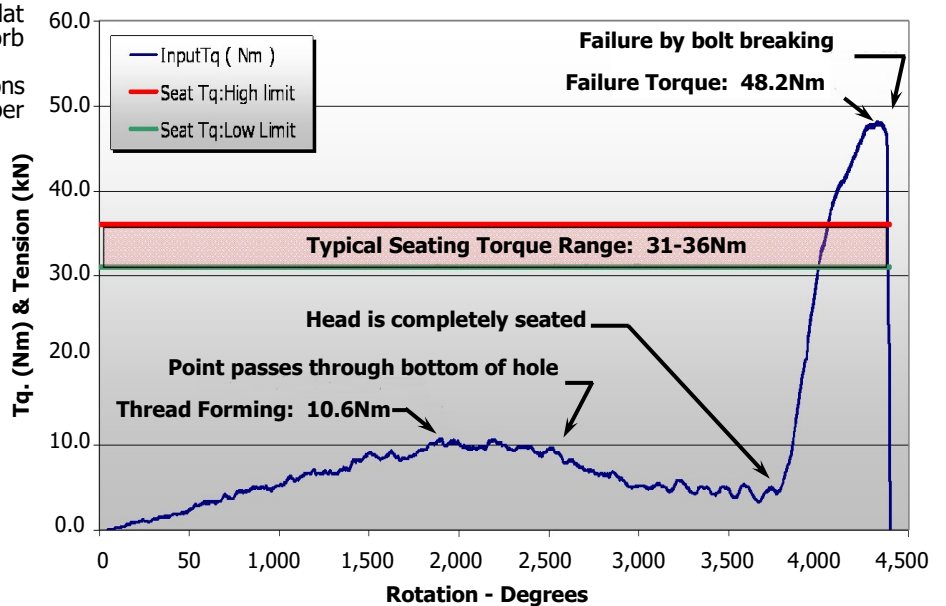



TAPTITE 2000[®] Fasteners

TAPTITE 2000[®] Fasteners Reduce the Cost of Assembly

2 Major Cost Savings Components Using TRILOBULAR[®] Fasteners

- Eliminates tapping and tapping related costs
- Eliminates cross threading

Advantages of Using TAPTITE 2000[®] Technology

- Reduces overall component cost
- Eases assembly resulting in less operator fatigue
- Speeds up assembly time
- Eliminates the need for add-on locking devices
- Supported by the customer's fastener suppliers
- Supported by REMINC/CONTI and fastener supplier personnel worldwide
- Procurement of TAPTITE 2000[®] products is available around the world

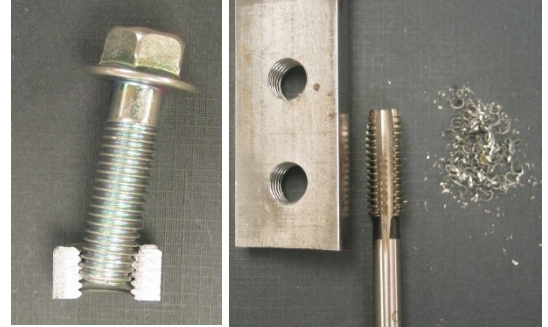

3 fastening elements
2 assembly directions
Manual assembly (complex)
2 assembly processes



1 fastening element
1 assembly direction
Automated assembly
1 assembly process

Standard Fastener Installation Components

- Labor
- Overhead
- Preparation of assembly
- Drilling and tapping the hole
- Application of locking device or adhesive
- Driving and tightening the screws

THESE COSTS MAKE UP THE **BIG 85**

Comparison of Total Joint Cost

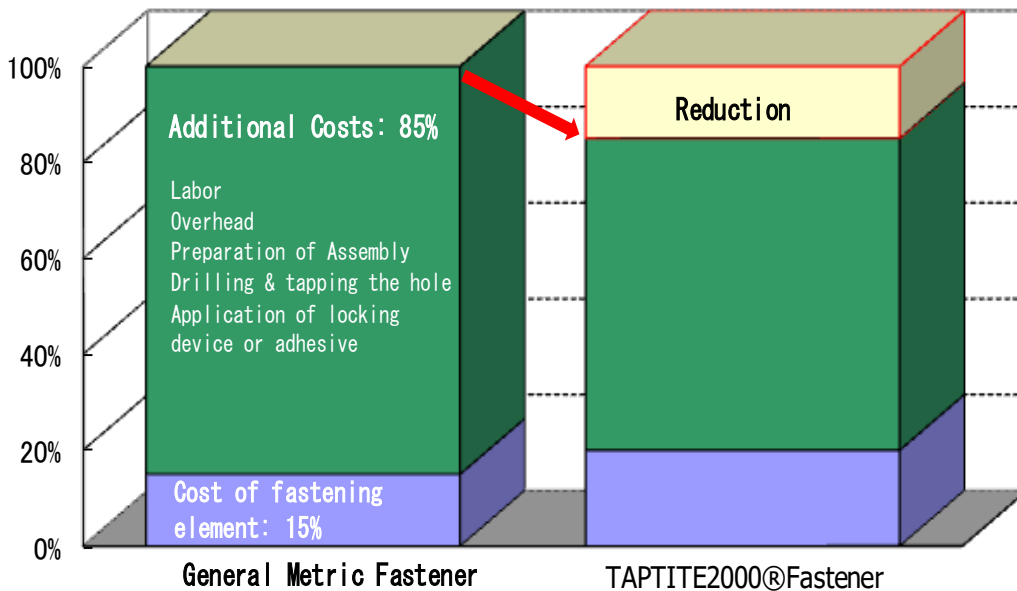

This chart shows a 10% increase in additional (assembly) costs results in an 8.5% increase in overall joint cost.

A 10% increase in fastener (product) costs results in only a 1.5% increase in overall joint cost.

There are no cheap or expensive fasteners. There are only economic or uneconomic methods of joining.

The cheapest fastener can become your most expensive joint.

REMINC/CONTI

Research Engineering & Manufacturing Inc. (REMINC) and Conti Fasteners AG (CONTI) have successfully marketed TAPTITE® fastener technology internationally since 1961. Their success has been accomplished by licensing and training leading fastener producers worldwide.

The technical program in the United States is under the direction of REMINC, located in Middletown, Rhode Island and in other countries under the direction of CONTI, situated in Baar, Switzerland.

Although REMINC and CONTI are separate corporations and operate independently, each is dependent on the other for certain functional activities.

AVAILABILITY

Currently there are over 100 qualified suppliers located in more than 20 countries utilizing the Technical Know-How, Patents, Trademarks, and Engineering and Marketing services of REMINC/CONTI. These producers delivered a volume in excess of 17,000,000,000 pieces of TRILOBULAR® fasteners in 2000, comprising a mix of products.

The proprietary products available in the program are marketed and sold, not as fastener items, but rather as **COST REDUCTIONS TO END-USERS OF ASSEMBLED PRODUCTS.**

The proprietary fasteners offered to the assemblers are the means to an end, i.e. used to generate cost reductions while at the same time providing reliably tightened joints.

ORDERING/SUPPLY

When ordering from qualified TRILOBULAR® fastener producers, be sure in all cases to specify the TAPTITE 2000® brand name, thread size, nominal length, head and point style, strength grade if CORFLEX®-'N' or CORFLEX®-'Y' is involved, any other special features required, finish, and of course, quantity.

DISCLAIMER CLAUSE

The values shown in this brochure are for guidance only. They are not meant to be used for design criteria. Their use and reliance thereon for any purpose by anyone is entirely voluntary and at the sole risk of the user. REMINC/CONTI are not responsible for any loss, claim, or damage resulting from their use. Consult our application engineers or the application engineering department of one of our many qualified producers for your specific application data.

TECHNICAL ASSISTANCE

This brochure contains basic information needed to achieve the cost-savings potential of TAPTITE 2000® fasteners.

To obtain further assistance and a list of qualified producers, visit our website at www.taptite.net or contact;

In North America;

REMINC
Tel: 401-841-8880
Fax: 401-841-5008
Email: reminc@reminc.net

In Europe and all other countries;

CONTI Fasteners AG
Tel: +41 (0)41/761 58 22
Fax: +41 (0)41/761 3018
Email: conti@contifasteners.ch

SERVICES

A summary of the capabilities of REMINC/CONTI in support of manufacturers:

Technical Support

- New Product Development
- Research and Development Reports
- Technical Manuals
- Technical Reports
- Technical Information Updates
- Engineering Consultation
- Computer Aided Design and Analysis
- Engineering Training
- Tooling Design and Procurement
- Manufacturing Guidance
- Manufacturing Cost Reduction
- Metallurgical Analysis
- End-User Application Guidance
- Technical Training Seminars

MARKETING SUPPORT

- Application Definition
- Application Reports
- Performance Documentation
- Sales Seminars
- Audio/Video Materials
- Graphics
- Customer Product Brochures
- Technical Liaison
- Joint Customer Visits
- Cooperative Studies
- Trademark and Patent Use

In addition to the above stated detail, REMINC/CONTI are positioned to provide:

- Contract Testing
- Contract Engineering
- Consultation Activities
- Contract Joint Analysis
- Fastener Engineering Training

TAPTITE 2000®, TRILOBULAR®, CORFLEX®, CORFLEX®-'Y', CORFLEX®-'N' are trademarks licensed by REMINC/CONTI.
COPYRIGHT 2013 by RESEARCH ENGINEERING & MANUFACTURING INC.

Research Engineering & Manufacturing Inc.
55 Hammarlund Way, Tech II, Middletown, RI 02842 USA
Tel: 401-841-8880 • Fax: 401-841-5008
www.taptite.com • E-mail: reminc@reminc.net



CONTI Fasteners AG
Albisstrasse 15, 6340 Baar (ZG) Switzerland
Tel: +41 (0)41/761 5822 • Fax: +41 (0)41/761 3018
www.taptite.com • E-mail: conti@contifasteners.ch